

POWER ANALYZER 3390

Power measuring instruments



Maximum accuracy of $\pm 0.16\%$ achieved with current sensors!

- Directly measure the primary and secondary sides of inverters
- Advanced motor analysis functions
- Measure inverter noise



CE

V
A

kW

Large Assortment of Wide-band, High-Precision Feed-Through Current Sensors

4 Models

**Effect of conductor position
Effect of external
electromagnetic field**

Completely Minimized

50A



CT6862

200A



CT6863

500A



9709

1000A



CT6865

NEW



ISO 9001
JMI-0216



ISO 14001
JQA-E-90091



www.hioki.com

HIOKI company overview, new products, environmental considerations and other information are available on our website.

Current Sensor Method

Surpasses the Accuracy of Direct Connection Method

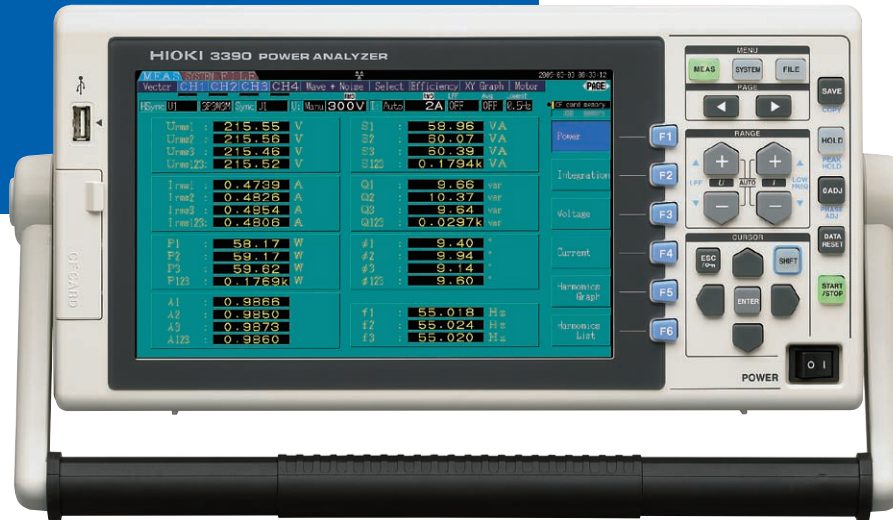

Power Analyzer 3390

When combined with the feed-through current sensors

Maximum accuracy of **$\pm 0.16\%$**

$\pm 0.1\%$

$\pm 0.06\%$



For Current Sensor specifications, please go to

page 15

Power Analyzing Control Engine Technology processes

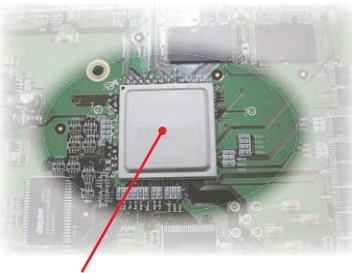

Measurement data at high speeds and with excellent accuracy

50ms

Weight & Volume

1/3

A HIOKI proprietary engine that takes advantage of the latest semi-conductor technologies enables a much smaller footprint than ever before (in comparison with other HIOKI high performance power meters)

Feed-through current sensors

Clamp-on sensors



9709



CT6862



9277



9272-10

Current sensor design allows for safe and efficient testing

- Choice of sensors include easy-to-measure AC and AC/DC clamp-on sensors and feed-through current sensors for high-accuracy measurements
- Immune to in-phase noise effects when measuring inverters

Basic accuracy of Model 3390: $\pm 0.1\%$

Basic measurement range: DC, 0.5 Hz to 5 kHz

(Frequency bandwidth: DC, 0.5 Hz to 150 kHz)

Effective input range: 1% to 110%

- High accuracy, wide band, and wide dynamic range
- Also measure the secondary side of DC inverters in conjunction with a variety of HIOKI current sensors

All data updated at 50ms*

- 50ms data refresh rate for all measurements unaffected by settings restraints
- Synchronize the measurements of multiple 3390s
Automatic update rate eliminates the need of switching for low-frequency measurements

* 50ms data refresh rate does not apply to waveform and noise analysis

Meet the Needs of Alternative Energy and Inverter or Motor Evaluations

4-channel isolated input

Measure the primary and secondary sides of inverters simultaneously

- Choose wiring from single-phase two-wire to three-phase four-wire
- Synchronize the measurements of multiple **3390s**



Even More!

- Connect up to four **3390s** and synchronize their clocks and measurement timing for multiple-channel measurements (using the SYNC terminal and Connection Cable **9683**)
- Use dedicated application software to conduct synchronized operations for up to 4 units and obtain all the measurement data

CF card interface & USB memory interface

Automatically save interval measurement data to a CF card (When saving manually, measured data and waveform data can be saved directly to the CF card and USB memory)



Connect an External Thermometer

- Data from temperature measurements taken with an external thermometer aids in motor evaluation
- Connecting the **3440 Series Temperature HiTESTER** (via the RS-232C interface) also allows temperature data to be collected simultaneously

▶ page 9



3440 Series

Waveform Output and 16 Channel D/A output

- Use the **D/A OUTPUT OPTION 9792** to update data every 50ms and output up to 16 items in analog format
- Also output the voltage and current waveforms for each channel (using 1 to 8 channels) (using 1 to 8 channels) (Waveforms are output at 500 kS/s and sinusoidal waveforms can be represented accurately at up to 20 kHz)

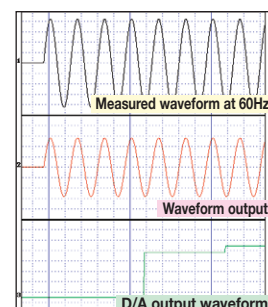
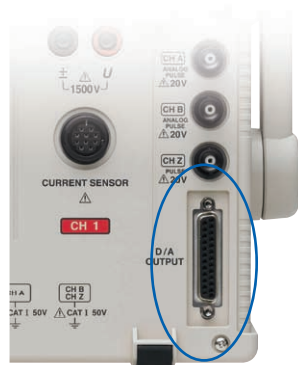

Ideal for Motor Evaluation and Analysis

- Use of the **MOTOR TESTING OPTION 9791 (or 9793)** allows torque meter output and rotation input, and facilitates motor power measurement

For motor evaluation and analysis specifications, please go to **pages 8 & 9**

A Variety of Interfaces Standardly Equipped

Includes 100Mbps Ethernet and USB 2.0 High Speed communications interfaces.

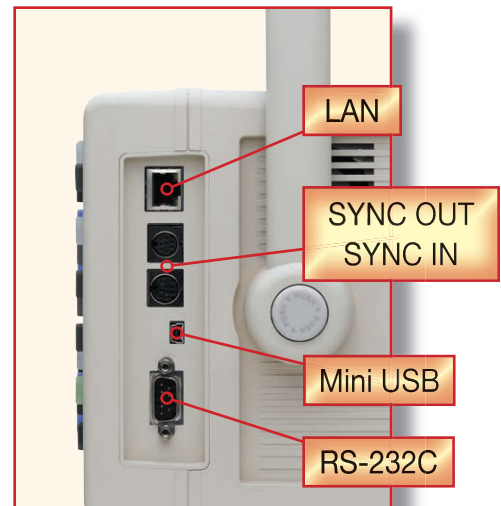

HTTP server function available with free dedicated PC software

- HTTP server function through web browser enables easy remote operation
- **Free dedicated PC application can be downloaded from the HIOKI website**

Collect data and operate the **3390** remotely by connecting it to a PC via LAN or USB

▶ page 11



Waveform Output and 16 Channel D/A output

- Use the **D/A OUTPUT OPTION 9792** to update data every 50ms and output up to 16 items in analog format
- Also output the voltage and current waveforms for each channel (using 1 to 8 channels) (using 1 to 8 channels) (Waveforms are output at 500 kS/s and sinusoidal waveforms can be represented accurately at up to 20 kHz)

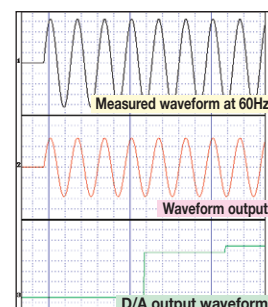

Extra-Large Screen Expands Possibilities

Capture measured data and waveforms at a glance utilizing a variety of display options

The 9" color LCD can display up to 32 data parameters

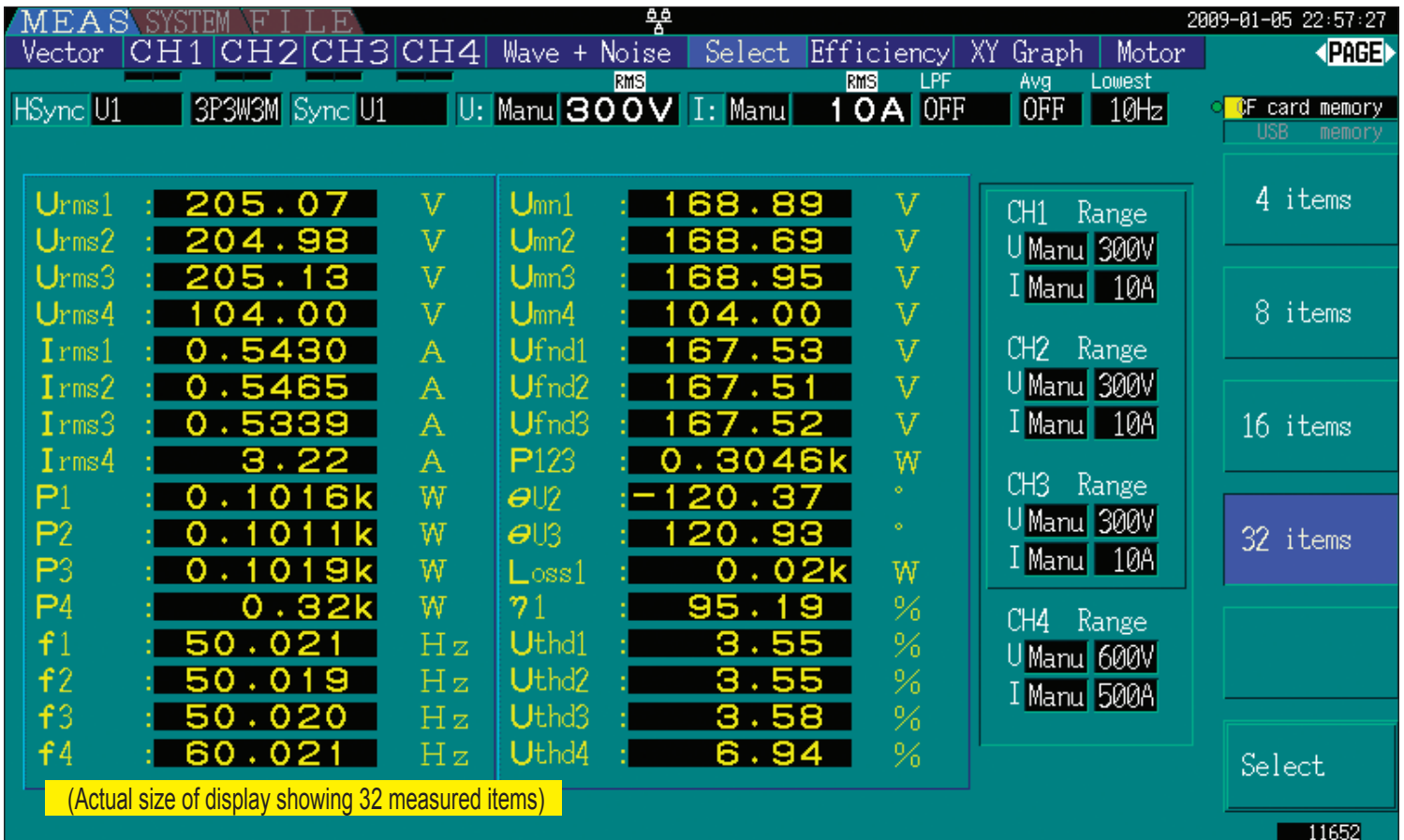

All measurements start with just a connection

Wiring check function prevents connection errors

Display connection and vector diagrams on the Wiring screen

Improve efficiency and reliability while saving time in wiring even for three-phase measurements

Display just the required data in an easy-to-read graphic interface on the Select screen

Screen displaying 32, 16, 8, or 4 items

Display items can be set individually for each selected screen

Read data quickly and easily by just switching between the screens

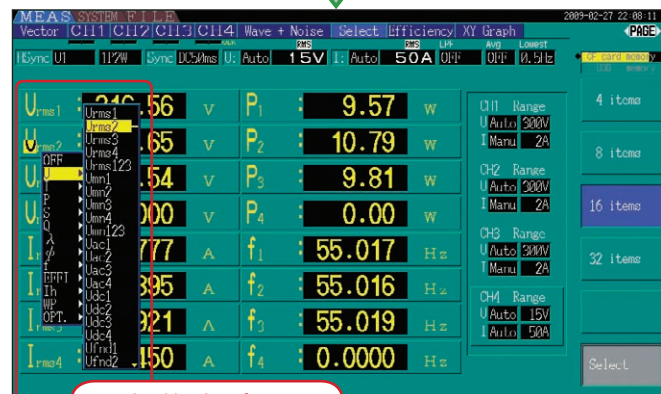
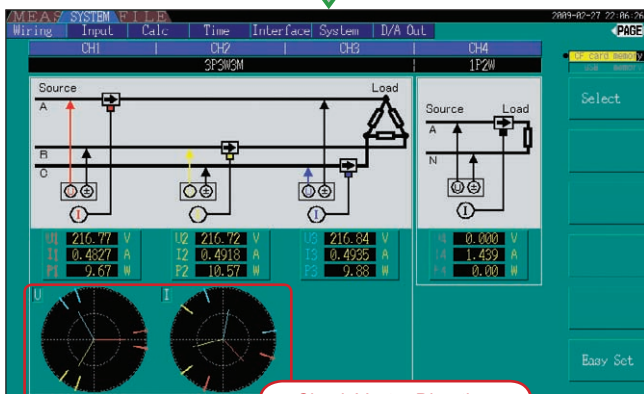

All data is processed in parallel simultaneously.

A wealth of data analysis functions all built-in and ready to use.

Channel display

RMS and MEAN values, and AC, DC, and fundamental waveform components can be measured and displayed simultaneously

| V rms value | | V mean value | |
|-------------------|----------|--------------------|----------|
| U _{rms1} | 205.07 V | U _{mn1} | 168.89 V |
| U _{rms2} | 204.98 V | U _{mn2} | 168.69 V |
| U _{rms3} | 205.13 V | U _{mn3} | 168.95 V |
| U _{rms4} | 104.00 V | U _{mn4} | 104.00 V |
| I _{rms1} | 0.5430 A | U _{fund1} | 167.53 V |
| I _{rms2} | 0.5465 A | U _{fund2} | 167.51 V |
| I _{rms3} | 0.5339 A | U _{fund3} | 167.52 V |

V fundamental value

Channel Display

One-touch Switching

Harmonic analysis display

Harmonics graph display



Harmonics list display

| Order | Amplitude | Phase | Power |
|-------|-----------|-------|-------|
| 1 | 100.00 | 0.00 | 0.00 |
| 2 | 0.00 | 0.00 | 0.00 |
| 3 | 0.00 | 0.00 | 0.00 |
| 4 | 0.00 | 0.00 | 0.00 |
| 5 | 0.00 | 0.00 | 0.00 |
| 6 | 0.00 | 0.00 | 0.00 |
| 7 | 0.00 | 0.00 | 0.00 |
| 8 | 0.00 | 0.00 | 0.00 |
| 9 | 0.00 | 0.00 | 0.00 |
| 10 | 0.00 | 0.00 | 0.00 |
| 11 | 0.00 | 0.00 | 0.00 |
| 12 | 0.00 | 0.00 | 0.00 |
| 13 | 0.00 | 0.00 | 0.00 |
| 14 | 0.00 | 0.00 | 0.00 |
| 15 | 0.00 | 0.00 | 0.00 |
| 16 | 0.00 | 0.00 | 0.00 |
| 17 | 0.00 | 0.00 | 0.00 |
| 18 | 0.00 | 0.00 | 0.00 |
| 19 | 0.00 | 0.00 | 0.00 |
| 20 | 0.00 | 0.00 | 0.00 |
| 21 | 0.00 | 0.00 | 0.00 |
| 22 | 0.00 | 0.00 | 0.00 |
| 23 | 0.00 | 0.00 | 0.00 |
| 24 | 0.00 | 0.00 | 0.00 |
| 25 | 0.00 | 0.00 | 0.00 |
| 26 | 0.00 | 0.00 | 0.00 |
| 27 | 0.00 | 0.00 | 0.00 |
| 28 | 0.00 | 0.00 | 0.00 |
| 29 | 0.00 | 0.00 | 0.00 |
| 30 | 0.00 | 0.00 | 0.00 |
| 31 | 0.00 | 0.00 | 0.00 |
| 32 | 0.00 | 0.00 | 0.00 |
| 33 | 0.00 | 0.00 | 0.00 |
| 34 | 0.00 | 0.00 | 0.00 |
| 35 | 0.00 | 0.00 | 0.00 |
| 36 | 0.00 | 0.00 | 0.00 |
| 37 | 0.00 | 0.00 | 0.00 |
| 38 | 0.00 | 0.00 | 0.00 |
| 39 | 0.00 | 0.00 | 0.00 |
| 40 | 0.00 | 0.00 | 0.00 |
| 41 | 0.00 | 0.00 | 0.00 |
| 42 | 0.00 | 0.00 | 0.00 |
| 43 | 0.00 | 0.00 | 0.00 |
| 44 | 0.00 | 0.00 | 0.00 |
| 45 | 0.00 | 0.00 | 0.00 |
| 46 | 0.00 | 0.00 | 0.00 |
| 47 | 0.00 | 0.00 | 0.00 |
| 48 | 0.00 | 0.00 | 0.00 |
| 49 | 0.00 | 0.00 | 0.00 |
| 50 | 0.00 | 0.00 | 0.00 |

Harmonic Analysis to the 100th Order

Switch screens at the touch of a button

Verify All Data At a Glance



Vectors display

Measured voltage, current, and power on channels 1 to 4 as numerical values and as vectors



Channel display

Measured power, voltage and current values, integration values, with access to harmonic graphs and lists for each channel.

| Channel | Value | Unit |
|-----------------|---------|------|
| U ₁ | 215.95 | V |
| U ₂ | 215.95 | V |
| U ₃ | 215.40 | V |
| U ₄ | 215.52 | V |
| I ₁ | 0.29438 | A |
| I ₂ | 0.29438 | A |
| I ₃ | 0.4834 | A |
| I ₄ | 0.4806 | A |
| P ₁ | 58.17 | W |
| P ₂ | 58.17 | W |
| P ₃ | 58.92 | W |
| P ₄ | 68.7493 | W |
| Q ₁ | 9.89 | var |
| Q ₂ | 10.97 | var |
| Q ₃ | 9.64 | var |
| Q ₄ | 17.923 | var |
| PF ₁ | 0.9850 | |
| PF ₂ | 0.9850 | |
| PF ₃ | 0.9876 | |
| PF ₄ | 0.9860 | |

Fast 500k/s



Wave+Noise display

Ideal for frequency analysis of inverter noise (FFT analysis)

Efficiency display

Simultaneously display efficiency and power loss

| | |
|---------------------|---------|
| Efficiency | 89.61 % |
| Efficiency | 88.50 % |
| Efficiency | 79.30 % |
| Loss P ₁ | 9.69 W |
| Loss P ₂ | 9.61 W |
| Loss P ₃ | 19.30 W |

XY graph display

Power and torque display makes it easy to understand the motor I/O characteristics

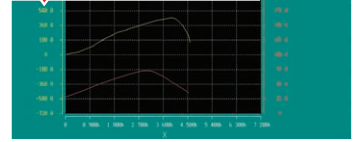

Feed-through Current Sensor Enable Extremely Accurate Measurements

HIOKI's high-performance feed-through current sensors absolutely minimizes the effects of conductor position and external fields, making them exceptionally precise. Repeatability and stability are absolutely unmatched!



Feed-through current sensors meet a large variety of applications from electric or hybrid vehicle testing, inverter motor evaluations and solar power devices and fuel cell analysis to individual testing of electrical appliances and facilities equipment.

*For further information and specifications, please refer to page 15.

Reference data (9709)

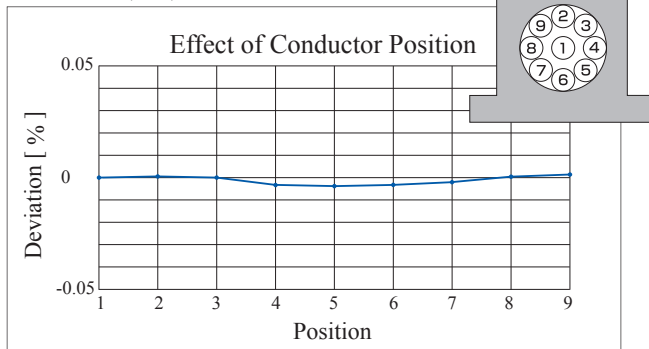

at 100ADC input, when measuring a 10mm diameter wire

Reference data (9709)

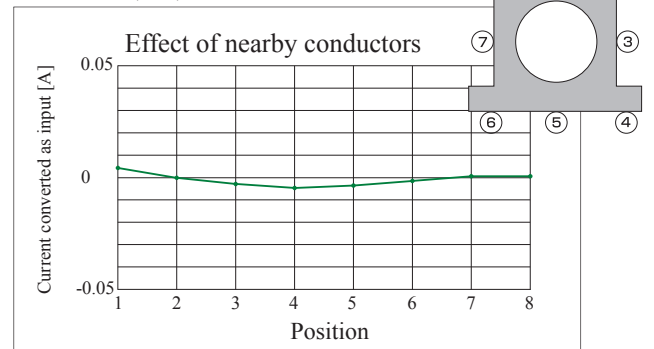

at 100ADC input, when measuring a 10mm diameter wire

Measure the primary and secondary sides of inverters

(Performance evaluation of motors and inverters)

Accurately and easily measure the power of inverters and motors for a wide range of applications, from research and development to field tests

Advantages

1. Isolated input of voltage and current lets you measure the power on the primary and secondary sides of inverters simultaneously.
2. Using a non-invasive current sensor makes the connection simple and easy. A vector diagram display ensures connections are checked.

Proprietary HIOKI Technology

3. Accurately measure the fundamental wave voltage and current values related to the motor axis output with confidence
4. All data is measured simultaneously and updated every 50 ms.
5. In addition to the harmonic analysis required to evaluate the inverter control, noise components can also be measured at the same time - ideal for determining the leakage of inverter noise
6. Use of a current sensor reduces the effect of in-phase noise from inverters when measuring the power

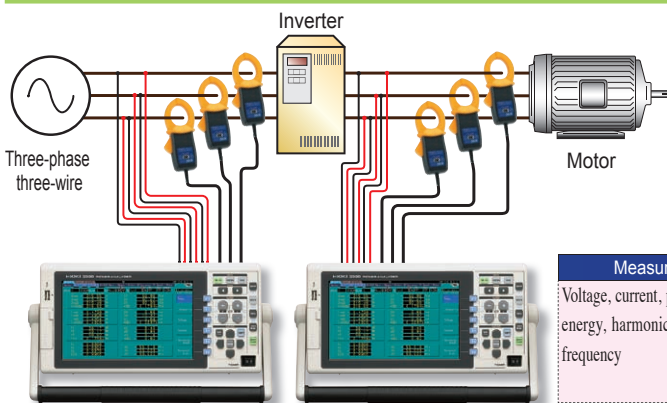

Measure the primary side of inverters
(Using channels 1, 2, and 3)

Measure the secondary side of inverters
(Using channels 1, 2, and 3)

Measurement parameters
Voltage, current, power, power factor, electrical energy, harmonic analysis, noise measurement, frequency

1 To ensure accurate measurements:

- Understand the connections and input states while looking at the connection diagram screen
- Checking unsure connections allows you to perform measurements without worry

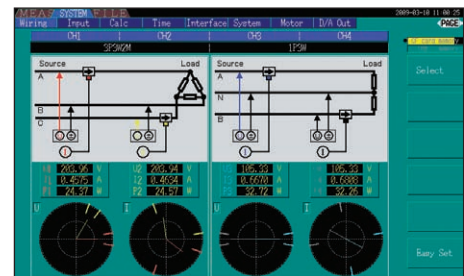

2 PC measurements and synchronizing multiple devices

- Dedicated application software allows you to perform PC measurements right out of the box
- LAN and USB compatibility facilitates efficient data collection and remote operation. Bundled application software allows you to control up to 4 units.

- Acquire all data even when multi-unit measurements are performed
- Two units can be connected using the **CONNECTION CABLE 9683** (option) to synchronize the internal clocks and control signals. Interval measurements with the two units allow the acquisition of perfectly synchronized data, making it easy to collect completely harmonized data with a CF card without using a PC.

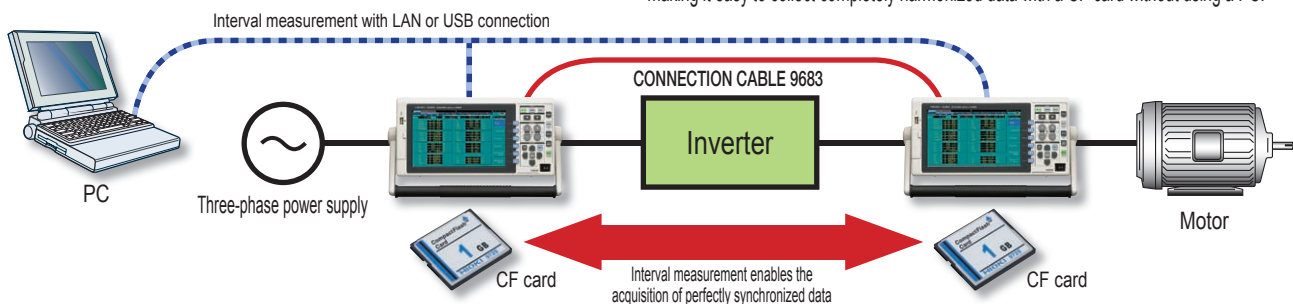

■ What's so special about inverter motors?

Inverter motors are indispensable as the power source of industrial equipment. The rotation of an induction motor depends on the input frequency, so if this input frequency can be made variable, the rotation can be controlled freely. Development of a frequency conversion technology called an inverter has made it possible to freely control the rotation of motors.

In recent years, the mainstream inverter control method is the **PWM (Pulse-width Modulation) method**.

● What is the PWM method?

A pseudo sinusoidal waveform (fundamental wave) resulting from the conversion of the fundamental wave frequency that determines the rotation of a motor to a pulse train called a carrier frequency (at about several kHz to 15 kHz) is effected, controlling the number of rotations.

● Performance evaluation and electrical measurement of motor

The axis output of a motor is closely related to the fundamental wave frequency to be input, so an accurate measurement of this fundamental wave component is required to evaluate the input characteristics.

● Conventional measurement method

Traditional methods use the average rectified RMS indication (Mean) in order to obtain a component value close to the fundamental wave frequency from a pseudo sinusoidal waveform (fundamental wave + carrier wave) to be input. To measure an accurate fundamental component, frequency analysis was required; however, the conventional processing method was not practical because it could barely perform real-time measurements with FFT as a result of the limited computing power.

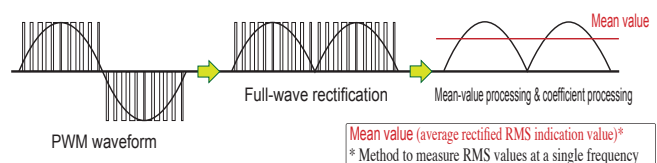

- The **3390** is capable of measuring the fundamental wave component accurately. The **3390** performs this frequency analysis using high-speed harmonic computation processing at an interval of 50 ms and displays the true fundamental wave component.

3 To make the best of inverter motor measurements:

- Parameters critical to the measurement of motor inputs (outputs on the secondary side of inverters) can be measured and displayed simultaneously.

| Display item | Measurement details |
|--------------|---|
| rms value | RMS value of fundamental wave + carrier wave components |
| mn value | RMS value (mean value) close to the fundamental wave component |
| fnf value | True fundamental wave component |
| thd value | Displays the distortion factor of measured waveform |
| unb value | Displays the balance between phases |
| ±pk value | Maximum positive/negative values of waveform that is being measured |
| dc value | Displays a DC component harmful to the motor |
| ac value | RMS value obtained by removing the DC component from the RMS value |
| f value | Frequency of each phase |

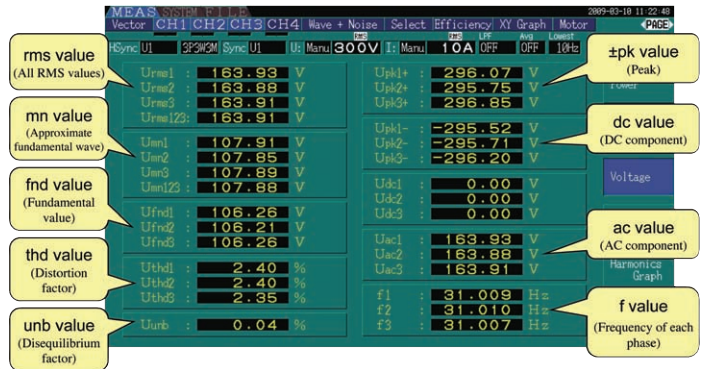

4 Clearly display efficiency and loss of inverters

- Efficiency and loss measurement function built-in

The operating efficiency and power loss of an inverter can be displayed when measuring the inputs and outputs of the inverter simultaneously.



5 X-Y graph display lets you check the dynamic characteristics of inverters

- X-Y graph display function built-in (X-axis: 1 item, Y-axis: 2 items)

By simply specifying the voltage for the X-axis and the power consumption and efficiency for the Y-axis, you can display the dynamic characteristics of a motor in real time.



6 Harmonic measurement indispensable for inverter evaluation

- 4-channel simultaneous harmonic analysis function built-in (Performed simultaneously with power measurement)

Harmonic analysis is essential for the development and evaluation of inverters Synchronized to the fundamental wave frequency from 0.5 Hz to 5 kHz Harmonic analysis up to the 100th order can be performed simultaneously with power measurement.

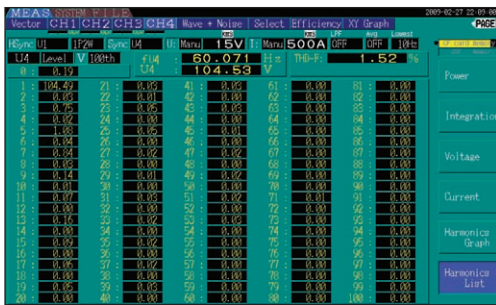

7 Evaluate of the troublesome noise of inverters

- Noise measurement function built-in (1-channel measurement: Performed simultaneously with power measurement and harmonic analysis)

Noise components at up to 100 kHz can be read while looking at the measured waveforms Simultaneously display the top 10 point frequency and voltage/current levels



8 Waveforms can be observed at 500 kS/s, and fundamental waves can also be checked

- Waveform monitoring function fully supported

Display the voltage and current waveforms being measured The carrier frequency components of an inverter are also displayed in real time

- Filter function

A filter function is used to remove the carrier frequency components from the inverter, and fundamental wave frequency waveforms can be checked in the waveform display.

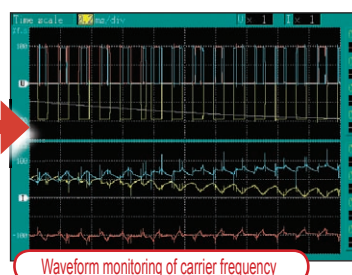
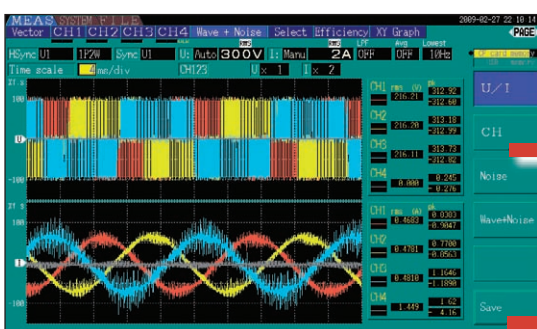

* The filter function is reflected in the measured values. Please be careful when you switch to the function during measurement.

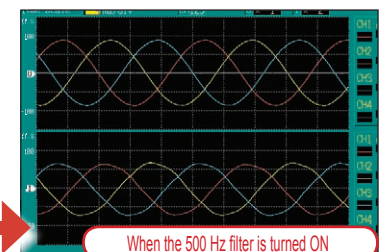

Geared for the latest motor evaluation and analysis of Hybrid Electric Vehicles, Electric Vehicles and the like

Drive the research and development of three-phase inverter motors with high accuracy and high-speed measurements

Advantages

1. Use of the **MOTOR TESTING OPTION 9791 (9793)** lets you perform a total evaluation of inverter motors
2. The voltage, torque, rotation, frequency, slip, and motor power required for motor analysis can be measured with one unit
3. Current sensors make the connection simple. In addition, use of the **AC/DC CURRENT SENSOR** enables measurements with superior accuracy

Proprietary HIOKI Technology

4. All data is measured simultaneously and updated every 50 ms. Data collection and characteristics tests can be performed at the industry's fastest speed
5. Evolution of electrical angle measurements critical to motor analysis has made it possible to perform more accurate measurements using an incremental encoder
6. Harmonic analysis at 0.5 Hz to 5 kHz without the need for an external timing mechanism
7. Built-in digital anti-aliasing filter (AAF) lets you measure the broadband power on the secondary side of inverters to make accurate harmonic analyses

● Example of HEV and EV measurement systems

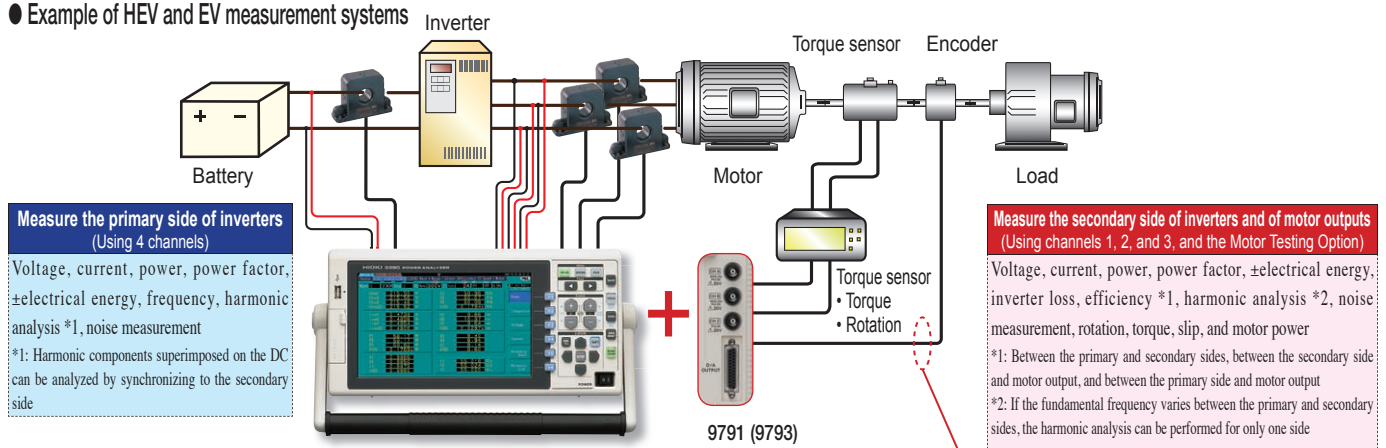

1 Evaluate high-performance vector control inverters:

- Measurements of fundamental wave voltage and current and their phases based on an accurate harmonic analysis are indispensable to motor analysis
- Support of an incremental encoder allows detecting synchronization signals from a motor easily and accurately

Electrical angle measurements are indispensable for dynamic characteristics analysis of motors.

The 3390 can conduct FFT analyses synchronized to rotation pulses from the tachometer and the motor induced voltage, and the A-phase and Z-phase pulse inputs that allow measuring and detecting the origin of the motor more simply and accurately – fully meeting the needs of the latest motor analysis tests.

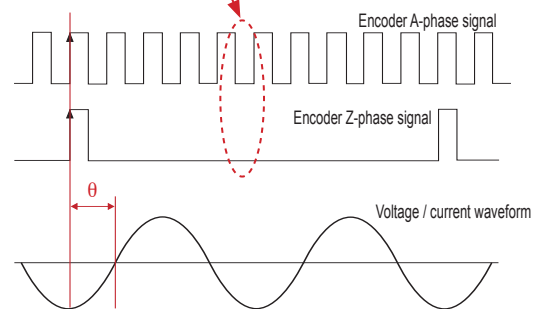

■ Application 1: "Electrical angle measurement"

- The voltage / current fundamental wave component " θ " from the machine angle origin can be calculated by performing harmonic analysis of motor input voltage / current by synchronizing to the A-phase signal and z-phase signal of an encoder.
- A function to perform zero compensation for this phase angle when a motor induced voltage is generated can be used to measure the voltage and current phase (electrical angle) in real time based on the induced voltage when the motor is started.

■ The importance of measuring the electrical angle of synchronous motors

The key to the performance of high-performance low-fuel consumption vehicles represented by HEV and EV is the synchronous motor that is used as the power source. The synchronous motor is finely controlled by alternating signals generated by an inverter device (DC to AC conversion) using the electricity from batteries.

● What is a synchronous motor?

A synchronous motor rotates in synchronization with the AC frequency. Structurally, the motor is turned by the rotating force at the magnetic pole of the rotator (rotator magnetic pole), which is generated by the rotating magnetic field generated by applying an alternating current to the magnetic field (stator magnetic pole). The rotation speed is synchronized to the speed of the rotating magnetic field, so the

speed can be controlled by changing the speed of the rotating magnetic field (power supply frequency). In addition, high operating efficiency is one of the advantages of the synchronous motor.

● Why is electrical angle measurement necessary?

In the case of a synchronous motor, a phase shifting occurs between the stator magnetic pole and the rotator magnetic pole due to a change in the load torque. This shifted angle and the torque force that can be generated by a motor have a close relationship, so it is important to understand this shifted angle (electrical angle) in order to achieve high-efficiency motor control.

● The 3390 provides a more accurate measurement method

The 3390 supports the incremental encoder output in addition to the measurement methods of the HIOKI 3194 Power HiTESTER – enabling you to measure this electrical angle more easily and accurately.

2 Analyze harmonic signals from the low-speed rotation range of motors

• Harmonic analysis from a synchronization frequency of 0.5 Hz
 Accurate measurements can be performed in the low-speed rotation range of motors without the need of an external clock.
 If the synchronization frequency is 45 Hz or more, analysis results are updated every 50 ms, so data analysis can be performed in real time.

| Synchronization frequency range | Window wave number | Analysis order |
|---------------------------------|--------------------|----------------|
| 0.5Hz to 40Hz | 1 | 100th order |
| 40Hz to 80Hz | 1 | 100th order |
| 80Hz to 160Hz | 2 | 80th order |
| 160Hz to 320Hz | 4 | 40th order |
| 320Hz to 640Hz | 8 | 20th order |
| 640Hz to 1.2kHz | 16 | 10th order |
| 1.2kHz to 2.5kHz | 32 | 5th order |
| 2.5kHz to 5.0kHz | 64 | 3rd order |

• Analyze up to the 100th order
 Synchronized to the fundamental wave frequency of 0.5 Hz to 5 kHz
 Simultaneously perform analysis up to the 100th order harmonic along with power measurement



3 Vector display of electrical angles of motors

• Display vectors including that of the phase angle and electrical angle ($\Delta\theta$) of fundamental wave voltage and current. The measured data can be used as parameters to calculate the L_d and L_q values.



4 Clearly view the inverter efficiency/loss and motor power

• Output, efficiency, and loss of inverter motors can be measured with one single unit
 Operating efficiency and power loss of the inverter and motor can be displayed when the inputs and outputs of the inverter are measured simultaneously.



5 X-Y graph display lets you check the dynamic characteristics of inverters

• X-Y graph display function built-in (X-axis: 1 item, Y-axis: 2 items)
 By simply setting 2 items to the Y-axis as with a 6-axis graph used to evaluate motors, you can display the characteristics of a motor and similar devices in real time.



6 Simultaneously measure temperature that is indispensable for motor evaluation

• Connect the HIOKI 3440 Series Temperature HiTESTER to measure changes in the motor temperature and acquire data as parameters for motor evaluation
 Connect the HIOKI 3440 Series Temperature HiTESTER to the 3390 (via the RS-232C interface) to acquire data while displaying the temperature.

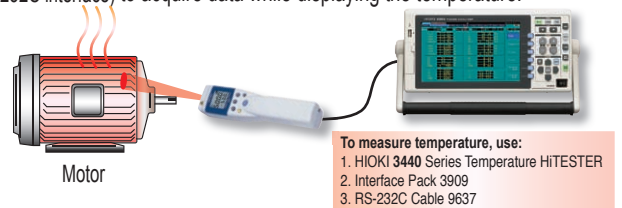

Application 2: Electrical angle measurement using induced voltage of motors (The same measurements conducted with the HIOKI 3194 can also be performed)

Correct the rotation synchronization signal and induced voltage phase of motors as well as measure the phase of voltage and current for the induced voltage of a running motor as an electrical angle.

Step 1: Turn the motor from the load side, and measure the induced voltage of the motor

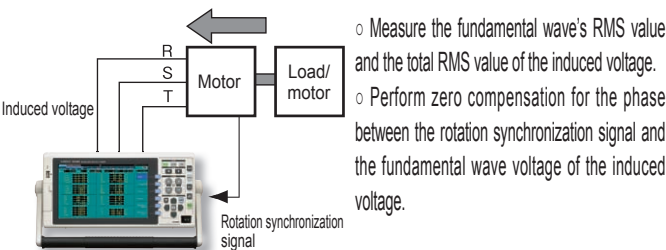

- o Measure the fundamental wave's RMS value and the total RMS value of the induced voltage.
- o Perform zero compensation for the phase between the rotation synchronization signal and the fundamental wave voltage of the induced voltage.

Step 2: Measurement of a running motor

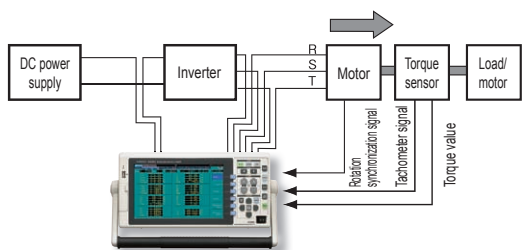

- o Measure the fundamental wave component, harmonic component, and electrical angle of line voltage and current of a line to the motor. (The measured data can also be used as parameters for calculation of L_d/L_q)
- o Simultaneously measure motor efficiency, inverter efficiency, total efficiency, and inverter loss while observing the motor control.

Other Advance Functionsmotor

- Frequency divider circuit (up to 1/60000 frequency dividing) – helpful when the rotation synchronization signal consists of multiple pulses for one cycle of induced voltage.
- Δ -to-Y conversation function - convert the line voltage to a phase voltage (virtual neutral reference) when three-phase three-wire (3P3W3M connection) measurements are performed.

Evaluate new energies such as solar power, wind power, and fuel cells

Assess power conditioners that are indispensable for converting new energies to electrical power

Advantages

1. The input and output characteristics of a power conditioner can be measured simultaneously in combination with an AC/DC current sensor
2. Use of a current sensor makes the connection simple. Make accurate measurements in combination with the AC/DC CURRENT SENSOR
3. The sale and purchase of electrical energy of a power line connected to a power conditioner can also be measured with one unit

Proprietary HIOKI Technology

4. Measure DC mode integration, which responds quickly to changes in the input of sunlight and the like, and RMS mode integration, which handles the separate integration of the sale and purchase of electric energy, all at the same time
5. Ripple factor, efficiency and loss, which are required to evaluate power conditioners for solar power generation, can be measured with one single unit.

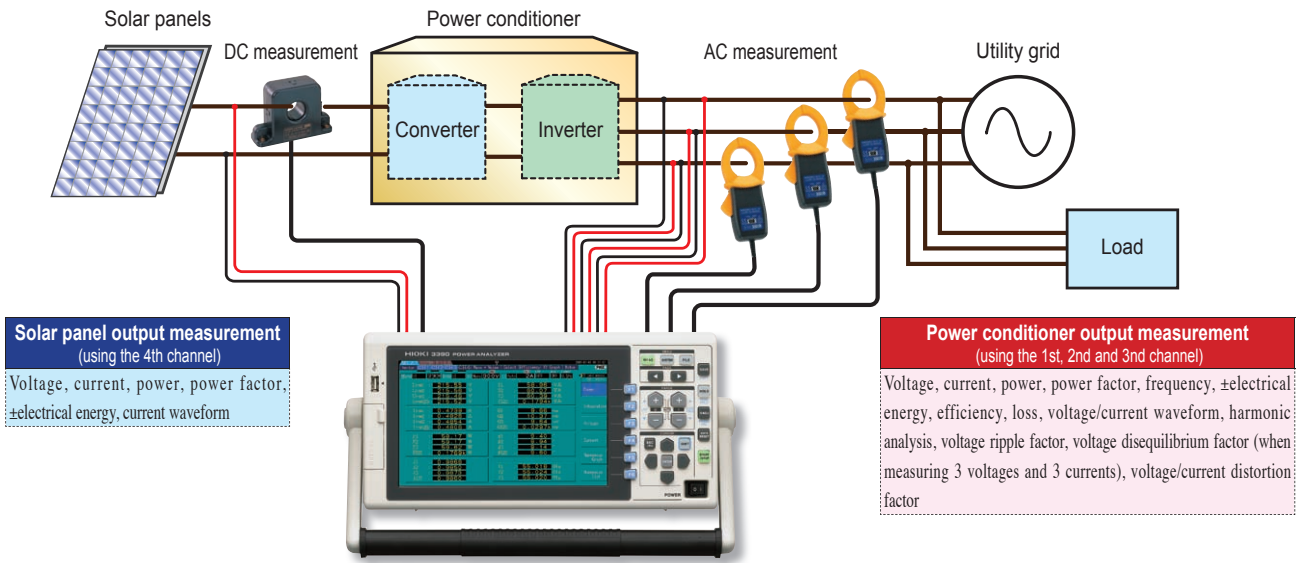

1 Conditioner-specific measurement items all measurable

• Power conditioner measurement-specific ripple factor and disequilibrium factor can also be measured and displayed simultaneously (up to 32 items can be displayed simultaneously), resulting in enhanced test efficiency

| Display item | Measurement item |
|-------------------|--|
| rms value | RMS (DC/AC voltage/current of input and output) |
| P, Q, S, λ values | Active power, reactive power, apparent power, power factor |
| Loss value | Input and output loss |
| η value | Efficiency |
| thd value | Distortion factor (voltage/current) |
| rf value | Ripple factor (for DC) |
| unb value | Disequilibrium |
| f value | Output frequency |

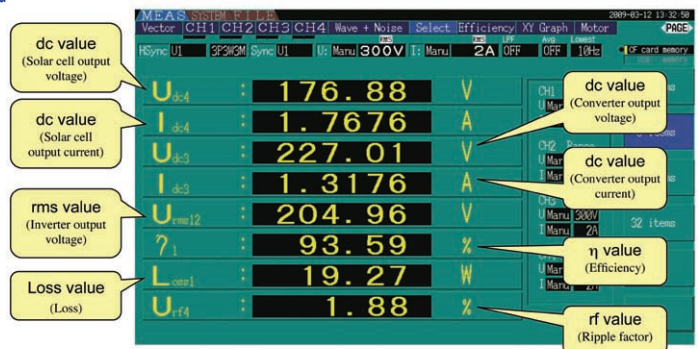

Current trends in solar power generation

● Interconnected system of solar power generation and power conditioner
Electrical energy generated from the solar power generation is DC electrical energy, so it needs to be converted to AC electrical energy to be used by connecting to the utility grid. The device to convert direct current to alternating current is the power conditioner. In particular, to sell electrical energy by connecting to the utility grid, the performance of the power conditioner is important, so the method to evaluate the performance is specified by the national standards.

● IEC standard

IEC 61683:1999, Photovoltaic systems -Power conditioners- Procedure for measuring efficiency

● Evaluation and measurement of power conditioners

The IEC standard stipulates detailed measurement items to evaluate the input and output characteristics of power conditioners such as harmonic level, ripple factor, voltage disequilibrium factor, and voltage/current waveform.

● The 3390 supports a long list of measurement items including the specific ones required.

The 3390 can measure ripple factor and evaluate and analyze through simultaneous measurements.

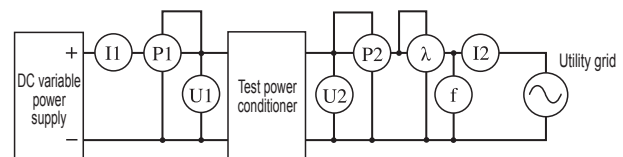

2 The efficiency (loss) and the amount of electrical energy sold and purchased can be displayed clearly

• Not only the amount of electricity generated with solar cells and the efficiency (loss) of a conditioner but also the amount of electrical energy sold and purchased by connecting to the utility grid can be measured simultaneously with one single unit



4 Accurately measure harmonics that are important for connecting to the utility grid

• The harmonic component and distortion factor important for connecting a power conditioner to the utility grid can be measured simultaneously. Synchronized to the fundamental frequency of 0.5 Hz to 5 kHz. Analyze up to the 100th order of voltage, current, and voltage harmonic, and display the current direction

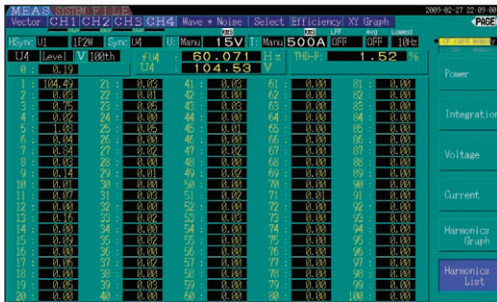

3 Check the input and output waveforms of a conditioner

• Simultaneously check the input and output waveforms of a conditioner at 500 kS/s. The input and output waveforms required to evaluate power conditioners can be checked simultaneously with one unit.

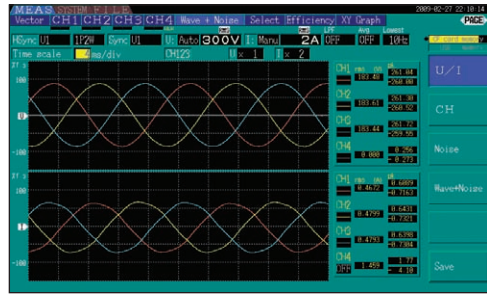

5 Also measure the noise flow of a connected utility grid

• Noise measurement function (1-channel measurement: Performed simultaneously with power measurement and harmonic analysis). Noise components at up to 100 kHz can be read while looking at the measured waveforms. Frequency and voltage/current levels for the top 10 points can be displayed simultaneously.

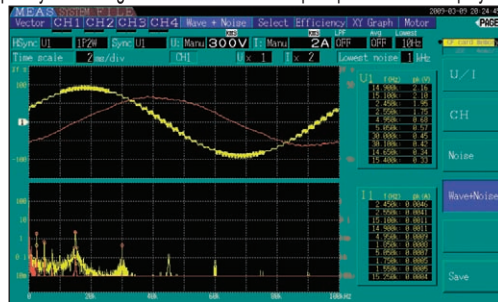

Bundled software dedicated to the 3390 (free download from the HIOKI website)

◆ Features

- Connect the 3390 to a PC via LAN or USB for completely remote operation
- Save measured data to the PC in real time (interval saving is also available)
- Download data stored in the USB memory or CF card
- Connect up to four 3390 Power Analyzers using the free software for remote operation and simultaneous data collection

| ■ General specifications | |
|--|---|
| Delivery media | Download from the HIOKI website |
| Operating environment | Windows 2000, XP, Vista, 7 PC Pentium III 500 MHz or higher CPU, 128 MB or more RAM, and LAN or USB interface Java Runtime Environment (JRE) 1.5.0 or later required |
| Communication method | Ethernet (TCP/IP), USB 1.1/2.0 For a USB connection, use the supplied dedicated driver (included with the software) |
| Number of simultaneously-connected units | 4 |
| ■ Functions | |
| Remote operation function | Key operation and screen display on a PC |
| Download function | Downloads data stored on the media (Files in the USB memory or CF card) |
| Display function | Displays instantaneously measured values of the 3390 on the PC monitor Numerical display: Basic measurement items Waveform display: Instantaneous waveform data Bar graph: Harmonic Vector: Fundamental wave vector |
| Measured value save function | Saves the specified instantaneous value data to the PC Selects the item to save from the numerical value display items in the display function |
| Interval save function | Saves instantaneous value data to the PC at the specified interval |
| CSV conversion function | Saves the displayed waveform data in CSV format to the PC |
| BMP save function | Saves the displayed waveform and graph data in image format to the PC or copy images to the clipboard |
| Setting function | Sends the settings of the 3390 made on a PC to the 3390 Setting contents can be saved and loaded to and from a file |

Real-time monitoring screen

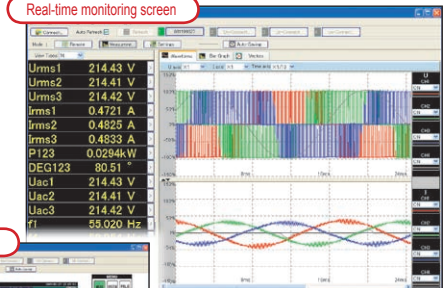

Remote operation screen

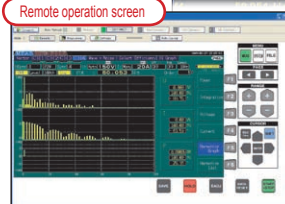

Connection of PC and 3390 via LAN or USB

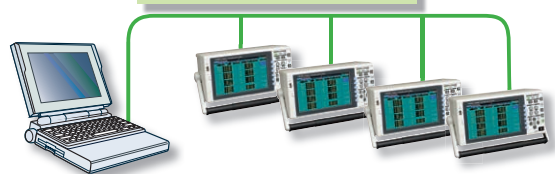

Up to 4 units can be connected using free software

3390 Specifications

(Accuracy guarantee conditions: 23°C ±3°C, 80%RH or less, warm-up time 30 minutes or more, sinusoidal wave input, power factor 1, voltage to ground 0 V, in the range where the fundamental wave meets the conditions of the synchronization source after zero adjustment)

| Input | | | | |
|---|---|------|--------|------|
| Measurement line | Single-phase two-wire (1P2W), single-phase three-wire (1P3W), three-phase three-wire (3P3W2M, 3P3W3M), three-phase four-wire (3P4W) | | | |
| Connection setting | CH1 | CH2 | CH3 | CH4 |
| Pattern 1 | 1P2W | 1P2W | 1P2W | 1P2W |
| Pattern 2 | 1P3W | | 1P2W | 1P2W |
| Pattern 3 | 3P3W2M | | 1P2W | 1P2W |
| Pattern 4 | 1P3W | | 1P3W | |
| Pattern 5 | 3P3W2M | | 1P3W | |
| Pattern 6 | 3P3W2M | | 3P3W2M | |
| Pattern 7 | 3P3W3M | | | 1P2W |
| Pattern 8 | 3P4W | | | 1P2W |
| Number of input channels | Voltage: 4 channels U1 to U4 Current: 4 channels I1 to I4 | | | |
| Input terminals | Voltage: Plug-in terminal (safety terminal) Current: Dedicated connector | | | |
| Input method | Voltage: Isolated input, resistance voltage dividing method Current: Isolated input using current sensor (voltage output) | | | |
| Measurement range | (Selectable for each connection, auto range available) | | | |
| Voltage range | 15.000V / 30.000V / 60.000V / 150.00V / 300.00V / 600.00V / 1500.0V | | | |
| Current range | *400.00mA / *800.00mA / 2.0000A / 4.0000A / 8.0000A / 20.000A (20 A rating) 4.0000A / 8.0000A / 20.000A / 40.000A / 80.000A / 200.00A (200 A rating) 1.0000A / 2.0000A / 5.0000A / 10.000A / 20.000A / 50.000A (50 A rating) 10.000A / 20.000A / 50.000A / 100.00A / 200.00A / 500.00A (500 A rating) * Only UNIVERSAL CLAMP ON CT 9277 is applicable | | | |
| Power range | Depends on combination of voltage and current range (6.0000 W to 2.2500 MW) | | | |
| Crest factor | 3 (voltage/current), 1.33 for 1500 V | | | |
| Input method (50/60Hz) | Voltage input part: 2 MΩ ±40 kΩ (Differential input and isolated input) Current sensor input part: 1 MΩ ±50 kΩ | | | |
| Maximum input voltage | Voltage input part: 1500 V ±2000 V peak Current sensor input part: 5 V ±10 V peak | | | |
| Maximum rated voltage to ground | Voltage input terminal 1000 V (50/60 Hz) Measurement category III 600 V (Expected transient overvoltage 6000 V) Measurement category II 1000 V (Expected transient overvoltage 6000 V) | | | |
| Measurement method | Voltage and current simultaneous digital sampling and zero cross synchronization calculation method | | | |
| Sampling | 500kHz / 16bit | | | |
| Frequency band | DC, 0.5 Hz to 150 kHz | | | |
| Synchronization frequency range | 0.5Hz to 5kHz | | | |
| Synchronization source | U1 to U4 / I1 to I4 / Ext (with motor analysis option, CH B: when pulse is set) / DC (50 ms, 100 ms fixed) * Selectable for each connection (Zero cross auto follow-up by digital LPF when U / I), Filter resistance two-stage switching (high / low), source input 30% f.s. or more when U / I | | | |
| Data update rate | 50ms | | | |
| LPF | OFF / 500 Hz / 5 kHz / 100 kHz (Selectable for each connection) When 500 Hz: Accuracy ±0.1% f.s. specified at 60 Hz or less When 5 kHz: Accuracy specified at 500 Hz or less When 100 kHz: Accuracy specified at 20 kHz or less (1%rdg. is added at 10k Hz to 20 kHz) | | | |
| Polarity determination | Voltage/current zero cross timing comparison method | | | |
| Polarity determination Measurement parameters | Voltage (U), current (I), active power (P), apparent power (S), reactive power (Q), power factor (λ), phase angle (φ), frequency (f), efficiency (η), loss (Loss), voltage ripple factor (Ufr), current ripple factor (Ifrr), current integration (Ih), power integration (WP), voltage peak (Upk), current peak (Ipk) | | | |

Accurate Voltage, currency, and active power measurements

| Accuracy | Voltage (U) | Current (I) | Active power (P) |
|------------------|----------------------|----------------------|----------------------|
| DC | ±0.1%rdg±0.1% f.s. | ±0.1%rdg±0.1% f.s. | ±0.1%rdg±0.1% f.s. |
| 0.5Hz to 30Hz | ±0.1%rdg±0.2% f.s. | ±0.1%rdg±0.2% f.s. | ±0.1%rdg±0.2% f.s. |
| 30Hz to 45Hz | ±0.1%rdg±0.1% f.s. | ±0.1%rdg±0.1% f.s. | ±0.1%rdg±0.1% f.s. |
| 45Hz to 66Hz | ±0.05%rdg±0.05% f.s. | ±0.05%rdg±0.05% f.s. | ±0.05%rdg±0.05% f.s. |
| 66Hz to 1kHz | ±0.1%rdg±0.1% f.s. | ±0.1%rdg±0.1% f.s. | ±0.1%rdg±0.1% f.s. |
| 1kHz to 10kHz | ±0.2%rdg±0.1% f.s. | ±0.2%rdg±0.1% f.s. | ±0.2%rdg±0.1% f.s. |
| 10kHz to 50kHz | ±0.3%rdg±0.2% f.s. | ±0.3%rdg±0.2% f.s. | ±0.4%rdg±0.3% f.s. |
| 50kHz to 100kHz | ±1.0%rdg±0.3% f.s. | ±1.0%rdg±0.3% f.s. | ±1.5%rdg±0.5% f.s. |
| 100kHz to 150kHz | ±20% f.s. | ±20% f.s. | ±20% f.s. |

* Voltage, currency, and active power values at 0.5 Hz to 10 Hz are reference values
* Voltage and active power values more than 220 V at 10 Hz to 16 Hz are reference values
* Voltage and active power values more than 750 V at 30 kHz to 100 kHz are reference values
* Voltage and active power values more than (2200/(kHz)) V at 100 kHz to 150 kHz are reference values
* Voltage and active power values more than 1000 V are reference values
* As for the current and active power values, add the accuracy of the current sensor to the above accuracy

| | |
|-----------------------------------|---|
| Accuracy guarantee period | 6 months (One-year accuracy is the above accuracy x 1.5) |
| Temperature coefficient | ±0.01% f.s / °C (When DC: Add ±0.01% f.s./°C) |
| Effect of common mode voltage | ±0.01% f.s. or less (When applying 1000 V (50/60 Hz) between the voltage input terminal and the case) |
| Effect of external magnetic field | ±1.0% f.s. or less (in a magnetic field at 400 A/m, DC, and 50/60 Hz) |

| | |
|-----------------------------|---|
| Effect of power factor | ±0.15% f.s. or less (When power factor = 0.0 at 45 Hz to 66 Hz), add ±0.45% f.s. when LPF is 500 Hz |
| Effective measurement range | Voltage, current, and power: 1% to 110% of range |
| Display range | Voltage, current, and power: Range's zero suppress range setting to ±120% |
| Zero suppress range | Selects from OFF, 0.1% f.s., and 0.5% f.s. * When OFF is selected, a numerical value may be displayed even if zero is input |
| Zero adjustment | Voltage: ±10% f.s. Current: ±10% f.s. zero correction is performed for an input offset less than ±4 mV |
| Waveform peak measurement | Range: Within ±300% of respective voltage and current range Accuracy: Voltage and current respective display accuracy ±2% f.s. |

Frequency measurement

| | |
|--------------------------------|--|
| Number of measurement channels | 4 channels (f1, f2, f3, f4) |
| Measurement source | Selects from U / I for each input channel |
| Measurement method | Reciprocal method + zero cross sampling value correction |
| Measurement range | Within synchronization frequency range between 0.5 Hz and 5 kHz |
| Data update rate | 50 ms (Depends on the frequency when 45 Hz or less) |
| Accuracy | ±0.05%rdg, ±1dgt. (When sinusoidal waveform is 30% or more relative to the measurement range of measurement source) |
| Display range | 0.5000Hz to 9.9999Hz / 9.900Hz to 99.999Hz / 99.00Hz to 999.99Hz / 0.9900kHz to 5.0000kHz |

Integration measurement

| | |
|---------------------------|---|
| Measurement mode | RMS / DC (Selectable for each connection, DC is only available when AC/DC sensor is used for 1P2W connections) RMS: Integrates the current RMS values and active power values, only the active values are integrated for each polarity DC: Integrates the current values and instantaneous power values for each polarity |
| Measurement item | Current integration (Ih+, Ih-, Ih), active power integration (WP+, WP-, WP) Ih+ and Ih- are available only in DC mode, and only Ih is available in RMS mode. |
| Measurement method | Digital calculation from each current and active power |
| Measurement interval | Data update rate of 50 ms |
| Display resolution | 999999 (6 digits + decimal point) |
| Measurement range | 0 to ±9999.99 TAh / TWh (Integration time is within 9999 h 59 m) If any integration value or integration time exceeds the above limit, integration stops. |
| Integration time accuracy | ±50 ppm ±1 dgt. (0°C to 40°C) |
| Integration accuracy | ±(Accuracy of current and active power) ± integration time accuracy |
| Backup function | If power fails during integration, integration resumes after power is restored |

Harmonic measurement

| | | | |
|---------------------------------|---|--------------------|----------------|
| Integration time accuracy | 4 channels (Harmonic measurement for another line at a different frequency cannot be performed) | | |
| Measurement item | Harmonic voltage RMS value, harmonic voltage percentage, harmonic voltage phase angle, harmonic current RMS value, harmonic current percentage, harmonic current phase angle, harmonic active power, harmonic power percentage, harmonic voltage/current phase difference, total harmonic voltage distortion factor, total harmonic current distortion factor, voltage disequilibrium factor, current disequilibrium factor | | |
| Measurement method | Zero cross synchronous calculation method (All channels same window) with gap | | |
| Synchronization source | U1 to U4 / I1 to I4 / Ext (Motor analysis option included, CHB: when pulse is set) / DC (50 ms/100 ms) | | |
| FFT processing word length | 32-bit | | |
| Anti-aliasing filter | Digital filter (Variable by the synchronization frequency) | | |
| Window function | Rectangular | | |
| Synchronization frequency range | 0.5 Hz to 5 kHz | | |
| Data update rate | 50 ms (Depends on the synchronization frequency when less than 45 Hz) | | |
| Phase zero adjustment | Phase zero adjustment is possible by key / communication command (only when the synchronization source is Ext) | | |
| Maximum analysis order | Synchronization frequency range | Window wave number | Analysis order |
| | 0.5Hz to 40Hz | 1 | 100th order |
| | 40Hz to 80Hz | 1 | 100th order |
| | 80Hz to 160Hz | 2 | 80th order |
| | 160Hz to 320Hz | 4 | 40th order |
| | 320Hz to 640Hz | 8 | 20th order |
| | 640Hz to 1.2kHz | 16 | 10th order |
| 1.2kHz to 2.5kHz | 32 | 5th order | |
| 2.5kHz to 5.0kHz | 64 | 3rd order | |

| | | |
|----------|----------------|--|
| Accuracy | Frequency | Voltage (U) / current (I) / active power(P) |
| | 0.5Hz to 30Hz | $\pm 0.4\% \text{rdg} \pm 0.2\% \text{f.s.}$ |
| | 30Hz to 400Hz | $\pm 0.3\% \text{rdg} \pm 0.1\% \text{f.s.}$ |
| | 400Hz to 1kHz | $\pm 0.4\% \text{rdg} \pm 0.2\% \text{f.s.}$ |
| | 1kHz to 5kHz | $\pm 1.0\% \text{rdg} \pm 0.5\% \text{f.s.}$ |
| | 5kHz to 10kHz | $\pm 2.0\% \text{rdg} \pm 1.0\% \text{f.s.}$ |
| | 10kHz to 13kHz | $\pm 5.0\% \text{rdg} \pm 1.0\% \text{f.s.}$ |

* Not specified when the synchronization frequency is 4.3 kHz or more

Noise measurement (FFT processing)

| | |
|----------------------------|--|
| Number of channels | 1 channel (Selects one channel from CH1 to CH4) |
| Measurement item | Voltage/current |
| Calculation type | RMS spectrum |
| Measurement method | 500 kHz/s sampling (Decimation after digital anti-aliasing filtering) |
| FFT processing word length | 32-bit |
| Number of FFT points | 1,000 points / 5,000 points / 10,000 points / 50,000 points (Linked to the waveform display record length) |
| Anti-aliasing filter | Digital filter auto (Variable by the maximum analysis frequency) |
| Window function | Rectangular / Hanning / flat top |
| Data update rate | Within about 400 ms to 15 s depending on the number of FFT points, with gap |
| Maximum analysis frequency | 100kHz / 50kHz / 20kHz / 10kHz / 5kHz / 2kHz |
| Frequency resolution | 0.2 Hz to 500 Hz (Determined by the number of FFT points and the maximum analysis frequency) |
| Noise value measurement | Calculates the levels and frequencies of voltage and current peaks (maximum values) for the top 10 points |

MOTOR TESTING OPTION (Applicable to the 9791 and 9793)

| | |
|---------------------------------|--|
| Number of input channels | 3 channels CH A: Analog DC input / frequency input (torque signal input) CH B: Analog DC input / pulse input (rotation signal input) CH Z: Pulse input (Z-phase signal input) |
| Input terminal form | Isolation type BNC connector |
| Input resistance (DC) | 1 M Ω \pm 100 k Ω |
| Input method | Isolated input and differential input (No isolation between CH B and CH Z) |
| Measurement item | Voltage, torque, rotation, frequency, slip, motor output |
| Maximum input voltage | ± 20 V (When analog / frequency / pulse) |
| Maximum rated voltage to ground | 50 V (50/60 Hz), measurement category I 50 V (Expected transient overvoltage of 500 V) |
| Accuracy guarantee period | 6 months (One-year accuracy is the accuracy below x 1.5) |

1. Analog DC input (CH A / CH B)

| | |
|-------------------------------|--|
| Measurement range | ± 1 V / ± 5 V / ± 10 V (When analog DC input) |
| Effective input range | 1% to 110% f.s. |
| Sampling | 10 kHz / 16-bit |
| Measurement method | Simultaneous digital sampling and zero cross synchronization calculation method (zero cross averaging) |
| Synchronization source | Same as the 3390 power measurement input specification (Common for CH A and CH B) |
| Accuracy | $\pm 0.1\% \text{rdg}$, $\pm 0.1\% \text{f.s.}$ |
| Temperature coefficient | $\pm 0.03\% \text{f.s.}/^\circ\text{C}$ |
| Effect of common mode voltage | $\pm 0.01\% \text{f.s.}$ or less when applying 50 V (DC 50/60 Hz) between the input terminal and the 3390 case |
| Display range | Range's zero suppress range setting to $\pm 120\%$ |
| Zero adjustment | Voltage $\pm 10\% \text{f.s.}$ |

2. Frequency input (only for CH A)

| | |
|---------------------------|---|
| Effective amplitude range | ± 5 V peak |
| Measurement range | 100kHz |
| Band width | 1kHz to 100kHz |
| Accuracy | $\pm 0.05\% \text{rdg}$, $\pm 3 \text{dgt.}$ |
| Display range | 1.000kHz to 99.999kHz |

3. Pulse input (only for CH B)

| | |
|---------------------------------|---|
| Detection level | Low: 0.5 V or less, High: 2.0 V or more |
| Measurement band | 1 Hz to 200 kHz (When duty ratio is 50%) |
| Frequency divider setting range | 1 to 60000 |
| Measurement frequency range | 0.5 Hz to 5.0 kHz (Specified by the frequency at which the measurement pulse is divided by the set frequency dividing number) |
| Minimum detection width | 2.5 μs or more |
| Accuracy | $\pm 0.05\% \text{rdg}$, $\pm 3 \text{dgt.}$ |

4. Pulse input (only for CH Z)

| | |
|-------------------------|---|
| Detection level | Low: 0.5 V or less, High: 2.0 V or more |
| Measurement band | 0.1 Hz to 1 kHz |
| Minimum detection width | 2.5 μs or more |
| Setting | OFF / ON (When ON, a frequency divider circuit of CH B is cleared by a rising edge) |

D/A OUTPUT OPTION (Applicable to the 9792 and 9793)

| | |
|---------------------------|-------------|
| Number of output channels | 16 channels |
|---------------------------|-------------|

| | |
|---------------------------|--|
| Output content | Switchable between Waveform output / Analog output (selects from the measurement items) * Waveform output is only for CH 1 to CH 8 |
| Output terminal form | D-sub 25-pin connector x 1 |
| D/A conversion resolution | 16-bit (Polarity + 15-bit) |
| Output voltage | Analog: DC ± 5 V f.s. (Max. about DC ± 12 V) Waveform output: 2 Vrms f.s., crest factor: 2.5 or more |
| Accuracy | Analog output: Measurement accuracy $\pm 0.2\% \text{f.s.}$ (DC level) Waveform output: Measurement accuracy $\pm 0.5\% \text{f.s.}$ (at RMS level, in synchronization frequency range) |
| Accuracy guarantee period | 6 months (one-year accuracy is the above accuracy x 1.5) |
| Output update rate | Analog output: 50 ms (As per the data update rate of the selected item) Waveform output: 500 kHz |
| Output resistance | 100 Ω ± 5 Ω |
| Temperature coefficient | $\pm 0.05\% \text{f.s.}/^\circ\text{C}$ |

Display

| | |
|----------------------|--|
| Display character | English / Japanese / Chinese (simplified characters) |
| Display | 9-inch TFT color LCD display (800 x 480 pixels) |
| LCD backlight | ON / Auto OFF (1min / 5min / 10min / 30min / 60min) |
| Display resolution | 99999 counts (Integrated value: 999999 counts) |
| Display refresh rate | 200 ms (Independent of internal data update rate; waveform and FFT depend on the screen) |
| Display screen | Measurement, Setting, File Manipulation screens |

External interfaces

1. USB Interface (Function)

| | |
|--------------------------|--|
| Connector | Series Mini-B receptacle |
| Electrical specification | USB2.0 (Full Speed / High Speed) |
| Number of ports | 1 |
| Class | Vendor specific (USB488h) |
| Destination | PC (Windows 2000 / XP / Vista (32-bit version)) |
| Function | Data transfer, remote operation, command control |

2. USB memory interface

| | |
|--------------------------|--|
| Connector | USB type A connector |
| Electrical specification | USB2.0 |
| Power supply | Up to 500 mA |
| Number of ports | 1 |
| Applicable USB memory | USB Mass Storage Class |
| Recordable items | Setting file: Save/Load Measured value/recorded data: Copy (from the CF card data) Waveform data: Save, screen hard copy |

3. LAN interface

| | |
|--------------------------|---|
| Connector | RJ-45 connector x 1 |
| Electrical specification | IEEE802.3 compliant |
| Transmission method | 10BASE-T / 100BASE-TX auto recognition |
| Protocol | TCP/IP |
| Function | HTTP server (remote operation), dedicated port (port transfer, command control) |

4. CF card interface

| | |
|----------------------------|--|
| Slot | TYPE I x 1 |
| Usable card | Compact flash memory card (32 MB or more) |
| Applicable memory capacity | Up to 2 GB |
| Data format | MS-DOS format (FAT16 / FAT32) |
| Recordable items | Setting file: Save / Load Measured value / automatically recorded data: Save (in CSV format) Waveform data: Save, screen hard copy |

5. RS-232C interface

| | |
|------------------|--|
| Method | RS-232C, EIA RS-232D, CCITT V.24, JIS X5101 compliant |
| Connector | D-sub 9-pin connector x 1 |
| Destination | thermometer |
| Recordable items | Full duplex asynchronous method Data length: 8, parity: none, stop bit: 1, Flow control: Hard flow, delimiter: CR+LF |
| Baud rate | 2400, 9600, 19200, 38400 bps (2400 bps for thermometer) |

6. Synchronization control interface

| | |
|-------------------------|--|
| Terminal form | IN-side 9-pin round connector x1, OUT-side 8-pin round connector x 1 |
| Signal | 5 V (CMOS level) |
| Maximum allowable input | ± 20 V |
| Signal delay | Up to 2 μs (Specified by the rising edge) |

Functions

1. Setting

| | |
|-------------------------|---|
| Rectification switching | rms / mean (Selectable for the voltage/current of each connection) rms: Displays the true RMS value (True RMS) mean: Displays the average-value rectified RMS value |
| Auto range | OFF / ON (Voltage and current range is selectable for each connection) |

| | | | | | |
|-------------------------------------|---|---------------------------|--------------------------------------|--------------------------------|---------------|
| Data save interval | OFF / 50 ms / 100 ms / 200 ms / 500 ms / 1 s / 5 s / 10 s / 15 s / 30 s / 1 min / 5 min / 10 min / 15 min / 30 min / 60 min * Maximum number of items to save can be specified by the setting (130 items/50 ms, up to 5000 items) | | | | |
| | Interval time and maximum number of items to be saved | | Auto-save (When using a 512 MB card) | | |
| | Interval | Number of items | Number of items to save | Maximum period | |
| | 50ms | 130 (When 200 ms: 520) | 10 40 | About 2 days About 14 hours | |
| 1s | 2600 (5 s or more: 5000) | 10 1000 | About 42 days About 11 hours | | |
| | | | | 1min | 5000 |
| Time control | OFF / Timer / Actual time When using Timer: 10 s to 9999 h 59 m 59 s (unit: 1 s) When using Actual Time: Start time / stop time (unit: 1 min) | | | | |
| Scaling | VT ratio: OFF / 0.01 to 9999.99 CT ratio: OFF / 0.01 to 9999.99 | | | | |
| Averaging | Displays the averaged values of all instantaneously measured values including harmonic value (Excluding the peak value, integrated value, and noise value) * Averaged data applies to all data including the saved data during averaging | | | | |
| Method | Exponential averaging (Applies to the data update rate of 50 ms) | | | | |
| Response time | OFF / 0.2s (FAST) / 1.0s (MID) / 5.0s (SLOW) (Time within which to fall in the accuracy range when the input changes to 0% f.s. to 100% f.s.) | | | | |
| Efficiency/loss calculation | Calculates the efficiency η [%] and loss [W] of active power for each connection and channel. | | | | |
| Calculated item | Active power value (P) for each channel and connection Motor power (Pm) when the 9791 and 9793 Motor Analysis Option is included | | | | |
| Calculation rate | Calculates and updates at a data update rate of 50 ms * The latest data of calculation is used for a calculation between connections whose synchronization sources are different | | | | |
| Calculable factors | 3 formats for the efficiency and loss, respectively | | | | |
| Calculation algorithm | Calculated item is specified for Pin and Pout in the format below $\eta = 100 \times Pout / Pin $, $Loss = Pin - Pout $ | | | | |
| $\Delta - Y$ calculation | Converts line voltage waveform to phase voltage waveform using the virtual neutral point for 3P3W3M connection Uses a phase voltage to calculate all voltage parameters including harmonic or voltage RMS value | | | | |
| Display hold | Stops and displays all displayed measured values and display update of waveforms | | | | |
| Data update | Updates data when the hold key is manipulated, when the interval is reached, and when an external synchronization signal is detected | | | | |
| Output data | D/A output, CF data save: Outputs the hold data (The waveform output continues, and the interval auto-save outputs data immediately before it is updated) | | | | |
| Peak hold | Displays and updates the maximum value for each of all measured data (without waveform display and integrated value) (While averaging is performed, the maximum value is applied to the measured value after averaging. This cannot be used in conjunction with the Hold function) | | | | |
| Data update | Data is cleared when the hold key is manipulated, when the interval is reached, and when an external synchronization signal is detected (Data is updated at an internal data update rate of 50 ms) | | | | |
| Output data | D/A output, CF data save: Outputs the peak hold data (The waveform output continues, and the interval auto-save outputs data immediately before it is cleared) | | | | |
| 2. Display | | | | | |
| Connection check screen | Displays the connection diagram and the voltage/current vector diagram * The right connection range is displayed in the vector diagram, so the connection can be checked. | | | | |
| Connection display screen | Displays measured power and harmonic values on channels 1 to 4 * The values are displayed for each measurement line pattern of combined connections | | | | |
| DMM screen | Basic Measurement screen, Voltage Measurement screen, Current Measurement screen, Power Measurement screen | | | | |
| Harmonic screen | Bar Graph screen, List screen, Vector screen | | | | |
| Select/Display screen | Selects and displays any 4, 8, 16, or 32 measurement items from all basic measurement items Display pattern: 4 items, 8 items, 16 items, or 32 items (4 pattern switching) | | | | |
| Efficiency/Loss screen | Displays the numerical values of efficient and loss set in the calculation algorithm Display pattern: 3 efficiency items, 3 loss items. | | | | |
| Waveform & Noise Measurement screen | Displays the voltage/current waveforms sampled at 500 kHz in a compressed screen * Displays the waveform and noise measurement (FFT calculation) result when noise measurement is performed | | | | |
| Trigger | Synchronization timing of harmonic synchronization source | | | | |
| Record Length | 1,000 points / 5,000 points / 10,000 points / 50,000 points x all voltage/current channels | | | | |
| Compression Ratio | 1/1, 1/2, 1/5, 1/10, 1/25, 1/50 (Peak-Peak compression) | | | | |
| Recording time | Recording speed / Recording length | 1,000 points | 5,000 points | 10,000 points | 50,000 points |
| | 500kS/s | 2ms | 10ms | 20ms | 100ms |
| | 250kS/s | 4ms | 20ms | 40ms | 200ms |
| | 100kS/s | 10ms | 50ms | 100ms | 500ms |
| | 50kS/s | 20ms | 100ms | 200ms | 1000ms |
| | 25kS/s | 40ms | 200ms | 400ms | 2000ms |
| | 10kS/s | 100ms | 500ms | 1000ms | 5000ms |
| X-Y Plot screen | Selects items on the horizontal and vertical axes from the basic measurement items and displays them in the X-Y graph * The graph is drawn at the data update rate, data is not recorded, and drawing data is cleared | | | | |
| Option | Horizontal axis: 1 item (with gauge display) Vertical axis: 2 items (with gauge display) | | | | |

| | | |
|--|---|--|
| Motor screen | Displays the measured values of the MOTOR TESTING OPTION 9791 (9793). Display pattern: Displays the numerical values of 4 items | |
| 3. Data save | | |
| Auto data save | Saves each measured value to the CF card at each interval | |
| Save destination | OFF / CF card (cannot be saved to the USB memory), the save destination folder can be specified | |
| Save itemAuto | Any item can be selected from all measured data, including harmonic value, and peak value of the noise measurement function | |
| Data format | CSV file format | |
| Manual data Save | Saves each measured value to each save destination when the SAVE key is pressed | |
| Save destination | USB memory / CF card, the save destination folder can be specified | |
| Save itemSave | Any item can be selected from all measured data, including harmonic value, and peak value of the noise measurement function | |
| Data format | CSV file format | |
| Screen hard copy | Saves the display screen to the save destination when the COPY key is pressed | |
| Save destination | USB memory / CF card * The save destination folder can be specified when USB memory or CF card is specified. | |
| Data format | Compressed BMP format (256 colors) | |
| Setting data save | Setting information can be saved and loaded to and from the save destination as a setting file (With the exception of language setting and communication setting) | |
| Save destination | USB memory / CF card (the save destination folder can be specified) | |
| 4. External connected equipment | | |
| Synchronized measurement | The 3390 master and 3390 slaves can be connected with synchronization cables to perform synchronized measurements * If the interval setting is identical, synchronized measurements can be saved automatically | |
| Synchronized item | Clock, data update rate (excl. noise measurement), integration start/stop, data reset, event | |
| Event item | Hold, manual save, screen copy | |
| Synchronization timing | Clock, data update rate, start/stop, data reset, event (During operation of the master by the key or via communication) | |
| Synchronization delay | Up to 5 μ s per connection, up to +50 ms per event | |
| Temperature measurement | Acquires the measured temperature values from the thermometer connected to the RS-232C interface | |
| Applicable thermometer | HIOKI thermometers capable of communication via RS-232C | |
| Number of channels | 1 channel | |
| 5. System | | |
| Display language | English / Japanese / Chinese | |
| Clock function | Auto Calendar, Auto Leap Year Adjustment, 24 Hour Meter | |
| Clock setting | Year, Month, Day, Hour, Minute Setting, Zero Second Adjustment | |
| Real time accuracy | Within ± 3 s / day (25°C) | |
| Beep tone | OFF / ON | |
| Screen color | COLOR1 / COLOR2 / COLOR3 / COLOR4 / MONO | |
| Start screen select | Connection screen / screen closed in the previous session (Measurement screen only) | |
| LCD backlight | ON / 1min / 5min / 10min / 30min / 60min | |
| Sensor recognition | Automatically recognizes the current sensor connected | |
| Alarm display | Voltage/current peak over threshold detection, synchronization source non-detection (Alarm mark on) | |
| Key lock | ESC key: ON/OFF by holding down the key for 3 seconds (Key lock mark on) | |
| System reset | Sets the equipment to the default (factory) settings (Communication settings are not changed) | |
| File manipulation | Media data list display, media formatting, new folder creation, folder file deletion, file copy between media | |

General specifications

| | |
|---|--|
| Operating location | Indoors, altitude up to 2000 m, contamination class 2 |
| Storage temperature and humidity ranges | -10°C to 50°C, 80%RH or less (No dew condensation) |
| Operating temperature and humidity ranges | 0°C to 40°C, 80%RH or less (No dew condensation) |
| Withstand voltage | For 15 seconds at 50/60 Hz AC5.312 kVrms: Between the voltage input terminal and the unit case AC3.32 kVrms: Between the voltage input terminal and the current input terminal / interface AC370 Vrms: Between the 9791 and 9793 input terminals (CH A, CH B, CH Z) and the unit case Between CH A and CH B / CH Z |
| | Safety: EN61010 |
| | EMC: EN61326-1 Class A, EN61000-3-2, EN61000-3-3 |
| | |
| Rated power supply voltage | 100 to 240 VAC (expected transient overvoltage of 2500 V), 50/60 Hz |
| Maximum rated power | 140VA |
| Dimensions | 340 W \times 170 H \times 157 D mm (13.39" W \times 6.69" H \times 6.18" D) (excluding protrusions) |
| Weight | 4.8 kg (169.3 oz.) (including the 9793) |
| Backup battery life | About 10 years (a reference value of a lithium ion battery used at 23°C to back up the clock, setting conditions, and integrated values) |
| Product warranty period | 1 year |

Basic calculation algorithms

| Connection | 1P2W | 1P3W | 3P3W2M | 3P3W3M | 3P4W |
|---|--|---|--|-------------------|------|
| Voltage and current RMS value (True RMS value) | $X_{rms}(i) = \sqrt{\frac{1}{M} \sum_{s=0}^{M-1} X_{(i)s}^2}$ | $X_{rms12} \text{ or } X_{rms34} = \frac{1}{2}(X_{rms(i)} + X_{rms(i+1)})$ | $X_{rms123} = \frac{1}{3}(X_{rms1} + X_{rms2} + X_{rms3})$ | | |
| Voltage and current average rectified RMS indication value | $X_{mn}(i) = \frac{\pi}{2\sqrt{2}} \frac{1}{M} \sum_{s=0}^{M-1} X_{(i)s} $ | $X_{mn12} \text{ or } X_{mn34} = \frac{1}{2}(X_{mn(i)} + X_{mn(i+1)})$ | $X_{mn123} = \frac{1}{3}(X_{mn1} + X_{mn2} + X_{mn3})$ | | |
| Voltage and current alternating-current component | $X_{ac}(i) = \sqrt{(X_{rms}(i))^2 - (X_{dc}(i))^2}$ | | | | |
| Voltage and current mean value | $X_{dc}(i) = \frac{1}{M} \sum_{s=0}^{M-1} X_{(i)s}$ | | | | |
| Voltage and current fundamental wave component | Fundamental wave value X1(i) based on the harmonic calculation result | | | | |
| Voltage and current peak value | Maximum value among X pk+(i) = X (i)s M Minimum value among X pk-(i) = X (i)s M | | | | |
| Active power | $P(i) = \frac{1}{M} \sum_{s=0}^{M-1} (U_{(i)s} \times I_{(i)s})$ | $P12 = P1+P2$ $P34 = P3+P4$ | $P123 = P1+P2+P3$ | | |
| <p>* In the cases of 3P3W3M and 3P4W connections, phase voltage is used for the voltage waveform U (i)s.</p> <p>(3P3W3M: U1s = (U1s-U3s)/3, U2s = (U2s-U1s)/3, U3s = (U3s-U2s)/3)</p> <p>* The polarity symbols of active power P indicate the power direction when power is consumed (+P) and when power is regenerated (-P).</p> | | | | | |
| Apparent power | $S(i) = U(i) \times I(i)$ | $S12 = S1+S2$ $S34 = S3+S4$ | $S_{12} = \frac{\sqrt{3}}{2}(S_1 + S_2)$ $S_{34} = \frac{\sqrt{3}}{2}(S_3 + S_4)$ | $S123 = S1+S2+S3$ | |
| <p>* Selects rms or mn for U(i) and I(i)</p> <p>* In the cases of 3P3W3M and 3P4W connections, phase voltage is used for the voltage U (i)</p> | | | | | |
| Reactive power | $Q(i) = \frac{1}{M} \sum_{s=0}^{M-1} (U_{(i)s} \times I_{(i)s} \sin(\theta))$ | $Q12 = Q1+Q2$ $Q34 = Q3+Q4$ | $Q123 = Q1+Q2+Q3$ | | |
| <p>* The polarity symbol si of reactive power Q indicates symbol [none]; lag and symbol [-]: lead.</p> <p>* The polarity symbol si(i) is determined by lead or lag of voltage waveform U (i)s and current waveform I (i)s for each measurement channel (i), and in the cases of 3P3W3M and 3P4W connections, phase voltage is used for the voltage waveform U (i)s.</p> | | | | | |
| Power factor | $\lambda(i) = \frac{P(i)}{S(i)}$ | $\lambda_{12} = \sin\left(\frac{P_{12}}{S_{12}}\right)$, $\lambda_{34} = \sin\left(\frac{P_{34}}{S_{34}}\right)$ | $\lambda_{123} = \sin\left(\frac{P_{123}}{S_{123}}\right)$ | | |
| <p>* The polarity symbol si of power factor λ indicates symbol [none]; lag and symbol [-]: lead.</p> <p>* The polarity symbol si(i) is determined by lead or lag of voltage waveform U (i)s and current waveform I (i)s for each measurement channel (i), and si12, si34, and si123 are determined by the symbol of Q12, Q34, and Q123, respectively.</p> | | | | | |

| Connection | 1P2W | 1P3W | 3P3W2M | 3P3W3M | 3P4W |
|---|--|--|--|---|------|
| Phase angle | $\phi(i) = \sin^{-1} \left(\frac{Q(i)}{S(i)} \right)$ | $\phi_{12} = \sin^{-1} \left(\frac{Q_{12}}{S_{12}} \right)$ | $\phi_{34} = \sin^{-1} \left(\frac{Q_{34}}{S_{34}} \right)$ | $\phi_{123} = \sin^{-1} \left(\frac{Q_{123}}{S_{123}} \right)$ | |
| <p>The polarity symbol si(i) is determined by lead or lag of voltage waveform U (i)s and current waveform I (i)s for each measurement channel.</p> <p>si12, si34, and si123 are determined by the symbol of Q12, Q34, and Q123, respectively.</p> | | | | | |
| (i): Measurement channel, M: Number of samples between synchronization timings, s: Sample point number | | | | | |

Motor analysis calculation algorithm

| Item | Setting unit | Calculation algorithm |
|---|---------------------|--|
| chA | V (DV voltage) | $\frac{1}{M} \sum_{s=0}^{M-1} A_s$ |
| | N•m / mN•m / kN•m | When analog DC: A [V] × chA scaling setpoint |
| | common (torque) | When frequency: (Measurement frequency - fc setpoint) × rated torque setpoint / fd setpoint |
| M: Number of samples between synchronization timings, s: Sample point number | | |
| chB | V (DC voltage) | $\frac{1}{M} \sum_{s=0}^{M-1} B_s$ |
| | Hz (frequency) | When analog DC: B[V] × chB scaling setpoint |
| | r/min (rotation) | When pulse input: Pole number setpoint × pulse frequency / 2 × pulse number setpoint |
| Pm | N•m (unit of chA) | (Indicated value of chA) × 2 × π × (indicated value of chB) / 60 |
| | mN•m (unit of chA) | (Indicated value of chA) × 2 × π × (indicated value of chB) / 60 / 1000 |
| | kN•m (unit of chA) | (Indicated value of chA) × 2 × π × (indicated value of chB) × 1000 / 60 |
| Calculation cannot be performed when the unit of chA is other than the above, or the unit of chB is other than r/min. | | |
| Slip | Hz (unit of chB) | 100 × input frequency - indicated value of chB / input frequency |
| | r/min (unit of chB) | 100 × 2 × 60 × input frequency - indicated value of chB × pole number setpoint / 2 × π × input frequency |
| Selects the input frequency from f1 to f4 | | |

Current sensors specifications (Accuracy guarantee period of 1 year with the exception of the 9709 for 6 months)

| Model | 9272-10 | 9277 | 9278 | 9279 (Non-CE mark product) |
|--|---|--|---|--------------------------------|
| Rated current | AC 20A/200A | AC/DC 20A | AC/DC 200A | AC/DC 500A |
| Maximum continuous input range | 50A/300A rms | 50A rms | 350A rms | 650A rms |
| Accuracy (45 to 66 Hz, DC: DC compatible sensor) | ±0.3%rdg.±0.01%f.s., ±0.2° ±0.5%rdg.±0.05%f.s., ±0.2° (30 minutes after power is turned on and after magnetization) | | | |
| Frequency characteristic | 1Hz to 5Hz: ±2%rdg.±0.1%f.s. 1kHz to 5kHz: ±1%rdg.±0.05%f.s. (±1.0°) 10kHz to 50kHz: ±5%rdg.±0.1%f.s. | DC to 1kHz: ±1.0% (±0.5°) 1 k to 50 kHz: ±2.5 % (±2.5°) 50 k to 100 kHz: ±5.0 % (±5.0°) 1 k to 10 kHz: ±2.5 % (±2.5°) 10 k to 20 kHz: ±5.0 % (±5.0°) | | |
| Effect of conductor position (at 100A/55Hz input, using with the wire 10mm diameter) | ±0.2%rdg. or less | ±0.2%rdg. or less (DC,55Hz) | ±1.5%rdg. or less (DC,55Hz) | ±1.5%rdg. or less (DC,55Hz) |
| Operating temperature and humidity | 100mA or less (in an AC electromagnetic field of 400 A/m, 60Hz) | Max. 0.2A (400 A/m, 55Hz and DC) | Max. 1A (400 A/m, 55Hz and DC) | Max. 2A (400 A/m, 55Hz and DC) |
| Operating temperature and humidity | 0°C to 50°C (-32°F to 122°F) 80%RH or less (No condensation) | 0°C to 40°C (-32°F to 104°F) 80%RH or less (No condensation) | | |
| Measurable conductor diameter | φ 46mm (1.81") | φ 20mm (0.79") | φ 40mm (1.57") | |
| Dimensions/weight | 78W×188H×35Dmm(3.07"W×7.40"H×1.38"D), 430g(15.2 oz.) | 176W×69H×27Dmm(6.93"W×2.72"H×1.06"D), 470g(16.6 oz.) | 220W×103H×43.5Dmm(8.66"W×4.06"H×1.71"D), 470g(16.6 oz.) | |

| Model | CT6862 | CT6863 | 9709 | CT6865 |
|--|--|---|--|--|
| Rated current | AC/DC 50A | AC/DC 200A | AC/DC 500A | AC/DC 1000A |
| Maximum continuous input range | 100A rms | 400Arms | 700A rms | 1200A rms |
| Accuracy (45 to 66 Hz, DC: DC compatible sensor) | ±0.05 %rdg.±0.01 % f.s. , ±0.2° (Right after power is turned on at DC and 16Hz to 400Hz) ±0.05 %rdg.±0.01 % f.s. , ±0.2° (10 minutes after power is turned on) | | | |
| Frequency characteristic | DC to 16 Hz: ±0.1%rdg.±0.02%f.s.(±0.3°) 5kHz to 10kHz: ±1%rdg.±0.02%f.s. (±1.0°) | | DC to 45Hz: ±0.2%rdg.±0.02%f.s.(±0.3°) 5kHz to 10kHz: ±2%rdg.±0.1%f.s. (±2.0°) 20kHz to 100kHz: ±30%rdg.±0.1%f.s. (±30°) | DC to 16Hz: ±0.1%rdg.±0.02%f.s.(±0.3°) 500Hz to 10kHz: ±5%rdg.±0.05%f.s. 10kHz to 20kHz: ±30%rdg.±0.1%f.s. |
| Effect to conductor position | ±0.01%rdg. or less (50A input, DC to 100Hz, using with the wire 5mm diameter) | ±0.01%rdg. or less (100A input, DC to 100Hz, using with the wire 10mm diameter) | ±0.05%rdg. or less (at 100ADC input, using with the wire 10mm diameter) | ±0.05%rdg. or less (1000A input, 50/60Hz, using with the wire 20mm diameter) |
| Effect of external electromagnetic field | 10mA or less | 50mA or less | 50mA or less | 200mA or less |
| Operating temperature and humidity | Scaled value, in a DC or 60Hz magnetic field of 400 A/m CT6862/CT6863/CT6965: -30°C to 85°C (-22°F to 185°F), 9709: 0°C to 50°C (-32°F to 122°F) 80%RH or less (No condensation) | | | |
| Measurable conductor diameter | φ 24mm (0.94") | φ 24mm (0.94") | φ 36mm (1.42") | φ 36mm(1.42") |
| Dimensions/weight | 70W×100H×53Dmm (2.76"W×3.94"H×2.09"D), CT6862: 340g(12.0 oz.), CT6863: 350g(12.3oz.) | | 160W×112H×50Dmm (6.30"W×4.41"H×1.97"D), 9709: 850g(30.0oz.) CT9895: 1000g(35.3oz) | |

Note1 : Includes derating characteristics Note2: No phase precision regulations

POWER ANALYZER



POWER ANALYZER 3390

Accessories: Instruction Manual × 1, Measurement Guide × 1, Power cord × 1, USB cable × 1, D-sub connector × 1 (when 9792 or 9793 is installed), Color label × 2

Ordering Information

Please purchase separately-sold voltage cord and current sensor for measurements.

A HIOKI-issued PC card is also necessary in order to save measured data.

Factory options cannot be installed after delivery.

Factory options (please specify at the time of order)



- MOTOR TESTING OPTION 9791
- D/A OUTPUT OPTION 9792
- MOTOR TESTING & D/A OUTPUT OPTION 9793

Options for voltage measurements



CAT III 1000V
CAT IV 600V

Voltage Cord L1000

Length : 3m (9.84ft); Red × 1, yellow × 1, blue × 1, gray × 1, and black × 4

Usage:

Indoor wiring in buildings and factories for measurements up to 1000 V; can also be used for internal voltage measurements of equipment up to 1000 V.



Enlarged view of the end



Grabber Clip 9243

Red × 1, black × 1

Usage:

Attaches to the end of the Voltage Cord L1000 or L9438-50.



CAT III 1000V
CAT IV 600V

Voltage Cord L9438-50

Length : 3m (9.84ft); Red × 1, black × 1



WIRING ADAPTER PW9000

For 3P3W WIRING



WIRING ADAPTER PW9001

For 3P4W WIRING

Usage:

Reduce voltage cords for easy wiring.

3390Rear-view
Voltage input
terminals



PW9001 connection example When used with Model L1000

PW9000
or
PW9001

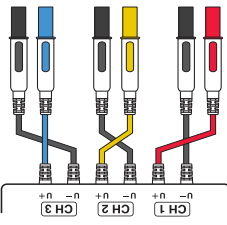

Note:

Dedicated PC application software and communication command manual are available for the 3390. Please download them from the HIOKI website.

Rack mounts available on special order. Please contact your local HIOKI office or distributor.

When using the 3390 with a DC power supply as in the case of on-vehicle measurements, a separate DC-AC converter is required.

Required DC-AC converter output specification

Output type : Sinusoid wave type, 50/60 Hz (60 Hz recommended)
Output capacity: The maximum power consumption of the 3390 is 140VA. Select a rating more than the capacity.

Options for current measurements

● AC/DC CURRENT SENSOR

CAT III 1000V



CT6862
(AC/DC 50A)

CAT III 1000V



CT6863
(AC/DC 200A)

CAT III 1000V



9709
(AC/DC 500A)

CAT III 1000V



CT6865
(AC/DC 1000A)

● CLAMP ON SENSOR

CAT III 600V



9272-10
(AC/DC 200A)

● UNIVERSAL CLAMP ON CT

CAT II 600V
CAT III 300V



9277
(AC/DC 20A)

CAT II 600V
CAT III 300V



9278
(AC/DC 200A)

Not CE-marked
600 V insulated conductor



9279
(AC/DC 500A)

PC Card



Supplied with PC Card adapter

9729

PC Card Precaution

Use only PC Cards sold by HIOKI. Compatibility and performance are not guaranteed for PC cards made by other manufacturers. You may be unable to read from or save data to such cards.

PC Card 256M 9727 (Capacity: 256 MB)
PC Card 512M 9728 (Capacity: 512 MB)
PC Card 1G 9729 (Capacity: 1 GB)
PC Card 2G 9830 (Capacity: 2 GB)

CARRYING CASE



CARRYING CASE 9794

Hard case dedicated to the 3390

448 W × 618 H × 295 D mm
(17.64" W × 24.33" H × 11.61" D)
(excluding protrusions)

Connection cables



CONNECTION CORD L9217
Length : 1.5m (4.92ft)
Usage :
For input of the 9791 and 9793



CONNECTION CABLE 9683
Length : 1.5m (4.92ft)
Usage :
For synchronized measurement



LAN CABLE 9642
Length : 5m (16.41ft)
supplied with straight to cross conversion cable

Combination example

1. General measurements (Three-phase three-wire (3P3W3M) single-circuit)



POWER ANALYZER 3390 × 1



VOLTAGE CODE L9438-50 × 3



200A SENSOR 9272-10 × 3



PC CARD 1G (1GB) 9729 × 1



CARRYING CASE 9794 × 1

2. Inverter input and output evaluation and measurements (Three-phase three-wire (3P3W2M) two-circuit)



POWER ANALYZER 3390 × 1



VOLTAGE CODE L1000 × 1



500A SENSOR 9709 × 4



PC CARD 1G (1GB) 9729 × 1



CARRYING CASE 9794 × 1

3. Motor evaluation and measurements (DC input / three-phase motor evaluation (DC, 3P3W3M measurements))



POWER ANALYZER 3390 × 1



VOLTAGE CODE L1000 × 1



500A SENSOR 9709 × 4



PC CARD 1G (1GB) 9729 × 1



MOTOR TESTING & D/A OUTPUT OPTION 9793 × 1

Note: Company names and Product names appearing in this catalog are trademarks or registered trademarks of various companies.

HIOKI

HIOKI E. E. CORPORATION

Headquarters :

81 Koizumi, Ueda, Nagano, 386-1192, Japan
TEL +81-268-28-0562 / FAX +81-268-28-0568
http://www.hioki.co.jp / E-mail: os-com@hioki.co.jp

HIOKI USA CORPORATION :

6 Corporate Drive, Cranbury, NJ 08512 USA
TEL +1-609-409-9109 / FAX +1-609-409-9108
http://www.hiokiusa.com / E-mail: hioki@hiokiusa.com

HIOKI (Shanghai) Sales & Trading Co., Ltd. :
1608-1610, Shanghai Times Square Office, 93 Huai Hai Zhong Road
Shanghai, P.R.China POSTCODE: 200021
TEL +86-21-63910090/63910092 FAX +86-21-63910360
http://www.hioki.cn / E-mail: info@hioki.com.cn
Beijing Office : TEL +86-10-84418761 / 84418762
Guangzhou Office : TEL +86-20-38392673 / 38392676
HIOKI INDIA PRIVATE LIMITED :
Khandela House, 24 Gulmohar Colony Indore 452 018 (M.P.), India
TEL +91-731-4223901, 4223902 FAX +91-731-4223903
http://www.hioki.in / E-mail: info@hioki.in
HIOKI SINGAPORE PTE. LTD. :
33 Ubi Avenue 3, #03-02 Vertex, Singapore 408868
TEL +65-6634-7677 FAX +65-6634-7477
E-mail: info@hioki.com.sg

DISTRIBUTED BY